

# City of West Palm Beach Makes Priority Improvements to Aging Water Treatment Plant

Gerardus Schers, Becky Hachenburg, Heath Wintz, Brian LaMay, Don Lythberg, Sam Heady, and Poonam Kalkat

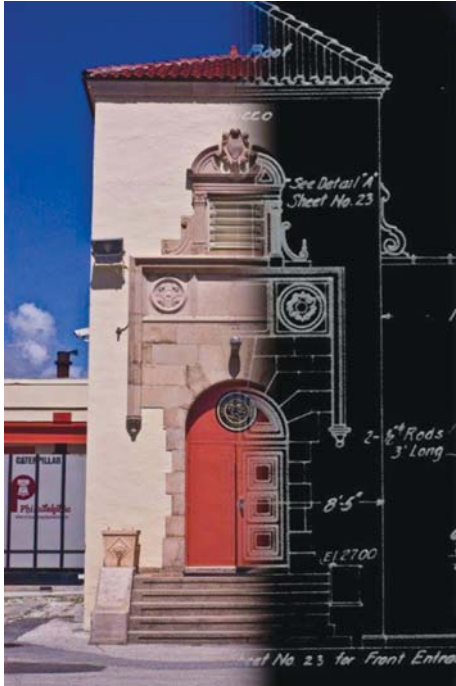

Figure 1. West High Service Pump Station, Constructed 1926. Photo of Current Building Overlaid With Original Design.

When the West Palm Beach Water Treatment Plant (WTP) was built by industrialist Henry Flagler in 1894, the facility used an average of four cords of wood per day to pump 1.5 mil gal of water per day (mgd) to Palm Beach and surrounding areas. Although the steam-driven pumps are long gone and the capacity of the facility has grown to 47 mgd, the founder of the Florida East Coast Railroad and Palm Beach would be proud to see his water WTP modernized with 21st-century technology.

The City of West Palm Beach's Public Utilities Department has ongoing major capital improvement projects at its WTP that will improve the reliability, safety, and security of its public water supply. The source of the surface water for the facility is a 20-sq-mi wetland catchment area known as the Grassy Waters Preserve, making the City one of the few utilities in the state of Florida to not use groundwater. This surface water is conveyed by a canal and two shallow lakes before ultimately reaching the WTP intakes in East Clear Lake. As with all surface water treatment facilities, rainfall, stormwater management, and other factors can provide fluctuations in raw water quality and

*Gerardus Schers is national water practice lead, Becky Hachenburg is senior client service lead, Heath Wintz is senior engineer, and Don Lythberg is construction manager with MWH in West Palm Beach. Brian LaMay is supervising engineer with MWH in Sunrise. Sam Heady is assistant utility director and Poonam Kalkat is water treatment plant manager with City of West Palm Beach.*

quantity that have provided challenges to the water treatment process.

The West Palm Beach WTP is located in the downtown corridor of a major metropolitan area, surrounded by residential homes, high-rise buildings, and businesses. In 2007, a series of bacteriological hits in the distribution system led to two boil-water notifications. Investigations by public utilities department staff, regulators, contract utility operators, and consulting engineers led to the discovery of an improperly sealed interconnect not shown on the as-built drawings,

*Continued on page 8*

Continued from page 6

which allowed filtered, chlorinated water to bypass the storage tanks without providing the contact time necessary for bacteriological and virus kill prior to distribution. Triage for the 100-year-old WTP involved the separation of filter backwash and side thickener supernatant return flows from the main treatment process, isolation of the interconnect to restore disinfection contact time, and replacement of inoperable valves and mechanical systems.

The City selected MWH, a global wet infrastructure engineering, consulting, and construction firm, to perform condition assessments, evaluations of alternative processes, bench- and pilot-scale process investigations, and design activities for the WTP improvements. In 2009, the City initiated several priority projects, identified, in part, by the condition assessment, that have been completed or are still under construction:

- ◆ Disinfection with liquid chemicals
- ◆ Safe access driveway to maneuver onto and off the WTP property
- ◆ Reliable electrical/generator building
- ◆ Dosing, mixing, and metering of finished water chemicals
- ◆ Automation of the treatment process
- ◆ High-service pumps rehabilitation

These projects are spread across the WTP site, as illustrated in the graphic, requiring close

coordination with the City's operations staff. The combined construction value of all priority projects, which includes the projects highlighted in this article, is around \$54 million.

As part of the priority projects, MWH provided hands-on training to the City's operations staff, with the goal to improve the understanding of the treatment process. Training sessions included concentration x contact time (CT) calculations for disinfection, jar testing for coagulation, and turbidity trending and reporting for media filtration. The training sessions resulted in a step change of the WTP operations, and this in itself provided a significant improvement to the water treatment process.

### Disinfection With Liquid Chemicals Improves Safety By Eliminating Hazardous Gasses

Prior to 2009, all disinfection chemical feed systems at the facility were operated manually. Gaseous chlorine and ammonia dosing were controlled by adjusting rotameters manually any time the process flow was changed. Conversion of gaseous chlorine to liquid sodium hypochlorite eliminated the need to store nearly 40 1-ton cylinders and 15 120-lb cylinders. Likewise, conversion of anhydrous ammonia to aqueous ammonia for chloramine disinfection eliminated the risk of a poisonous gas leak within the city.

Installation of variable frequency drives (VFD) controlled metering pumps for the liquid chlorine and ammonia systems, and remote monitoring of residual-free and combined chlorine allowed for remote operation and control of the dosing pumps as the supervisory control and data acquisition (SCADA) system developed.

During the design of the sodium hypochlorite system,

the need for close coordination among project teams became apparent. In an effort to provide operational flexibility, an existing underground ammonia pipeline and injection point was modified to add an additional chlorine injector. A leak from an incorrectly installed chlorine pipe allowed a stream of chlorine solution to spray and attack the stainless steel ammonia pipeline. The chemical and material incompatibility led to a gaseous ammonia leak in a confined space under the WTP's primary entrance/exit driveway, resulting in an evacuation from that area and a temporary blockage of traffic using the driveway. This situation not only brought to light the need for an intrinsically safe chemical injection point and centralized residual monitoring, but also the need to reduce vehicular traffic near critical WTP assets.

### New Access Driveway Provides Safe Maneuvering Onto and Off the WTP Property

The vulnerability assessment confirmed the primary entrance to the West Palm Beach WTP as a risk for the City, given its proximity to critical assets. All vehicular traffic for the facility was required to navigate through the oldest part of the facility, which contained transfer and high-service pumping, finished water chemical dosing, emergency power generation, and electrical switchgear. Additionally, access from Banyan Boulevard was unsafe without the presence of proper turn lanes for maneuvering on and off the WTP property.

To reduce the risk presented by this entrance, a new plant-access driveway was constructed along the north side of the property from Australian Avenue—a larger thoroughfare. This new access driveway included a dedicated turn lane, security guard checkpoint, video surveillance, and card-swipe-access control for the City staff. Chemical deliveries, sludge transport,

Continued on page 10



Figure 2. West Palm Beach WTP Site Plan with Priority Projects Highlighted.



Figure 3. Safe Access Driveway from Australian Avenue.

Continued from page 8

and traffic from ongoing construction are now safely separated from the critical assets.

## Water Treatment Plant Reliability Improved With New Electrical/Generator Building

Following Hurricanes Frances and Jeanne in 2004, the standby generators of the West Palm Beach WTP failed. A natural sense of urgency prompted the City to purchase two 2,000 kW remanufactured generators to provide generator power to the WTP. The new generators proved too large for the building, prompting the removal of the roof and façade and creating other challenges, such as a fan-driven rainwater short in the NEMA1 electrical equipment, failure of the automatic transfer switch, failure of a generator stator, and noise complaints from nearby residential neighbors.

Additionally, the switchgear for the WTP was constructed in 1985 as part of a new building that also housed the transfer and high-service pumps. During a loss of utility power, and

subsequently a failure of the generators, the transfer pump clearwell overflowed within just 15 min and flooded the building, threatening the adjacent electrical switchgear on the first floor.

To address these issues, MWH designed a new electrical/generator building and a dedicated “express” electrical feed from the Evernia Street substation located on the WTP site. The new generator building includes three 2,500 kW generators, an air intake rain knockdown plenum, sound damping exhaust plenum, and a new Florida Power and Light transformer vault, as well as 4160V primary and generator switchgear. The express electrical feed, augmented with two additional utility feeds from the Evernia and West Palm Beach substations, provides power to the double-ended switchboards and subsequently to all equipment, with an option to seamlessly transfer between utility and on-site generated power. This transfer feature is of critical importance during the wet season, allowing seamless transitioning between preferred power sources. Proactive management between sources helps to navigate through brownouts and blackouts and avoids interruptions to the treatment process and high-service pumping. This project also eliminates or replaces many obsolete loop switches, motor control centers, and electrical distribution panel boards.

Historically, constant speed motors have shut down at the WTP upon utility power failure. As

part of the improvements to the facility, a number of VFDs have been added and programmed for power loss “ride-through” by using the capacitors in the direct current bus of the drives. The primary function of these capacitors is to filter the voltage and provide a stable direct current source for the inverter section of the drive. However, through VFD programming, these capacitors can discharge over a three-second switchover to standby power, avoiding a process interruption or a pressure loss in the distribution system during brownouts and short blackouts. These VFDs provide the added benefit of reducing current in-rush to the motors in order to “peak-shave” electrical demands of the facility, reducing electricity costs.

Construction of the generator building at the heart of an aged facility has not been without challenges. During construction, unreliable record drawings of underground utilities and inoperable isolation valves complicated the relocation of a 42-in. finished water line. To facilitate the relocation, 42-in. and 24-in. line stops were installed to bypass this section of the pipeline, which was nearly 15 ft deep and located only 25 ft away from a railway. The project team members, including MWH, ensured that adequate shoring and thrust restraint was provided for this hot tap. The work was done successfully and this section of pipe was bypassed, while protecting the arterial line supplying potable water to the downtown area.

## Dosing, Mixing, and Metering of Finished Water Chemicals Stabilizes Finished Water Quality

Initial investigations in 2008 revealed that the mixing of disinfection chemicals was insuf-



Figure 4A. New Electrical/Generator Building Increases Reliability of WTP Service.

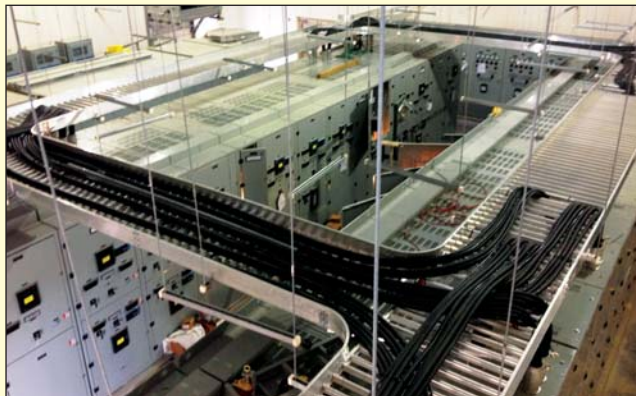

Figure 4B. View on Double-Ended Main and Generator Switchgear.



Figure 5. 42-in. Line Stop to Bypass In-Service Water Main Supplying.

ficient. Chlorine and ammonia were being injected into a 60-in. gravity, prestressed cylindrical concrete pipe (PCCP) immediately upstream of the transfer pump clearwell. Although transfer pump impellers provided the mixing energy downstream, quiescent plug flow through the 125,000-gal clearwell did not provide the favorable conditions necessary for immediate and complete monochloramine formation.

During the construction of the sodium hypochlorite system, a chemical piping trench was added to accommodate all finished water chemical pipelines from the dosing pumps to a new central dosing point. Prior to the construction of this piping trench, finished water chemical feed lines were spread over multiple corridors to multiple injection points across the property. These finished water chemicals included sodium hypochlorite, ammonium hydroxide, sodium hydroxide, ortho/polyphosphate blend, and hydrofluosilicic acid.

The existing chemical injection points relied on turbulence from fittings and pipe bends, which provided incomplete mixing and reaction. Furthermore, finished water chemicals were dosed based on an aggregate flow from 26 individual filter effluent flow meters. With an inaccuracy of +/- 0.5 percent each, the total inaccuracy of the finished water flow signal could be as high as +/- 13 percent. To alleviate these issues, the City constructed an above-grade 48-in. in-line static mixer and a centralized venturi flow meter between the transfer pump station and the ground storage tanks. Since the system only has enough storage to be off line for 8 hours, the design included a 20 mgd temporary bypass system from the transfer pump clearwell to the ground storage tanks to enable the WTP to remain in service during the construction tie-ins.

The centralized flow meter provides a signal by which all finished water chemicals are flow-paced with greater accuracy and reliability. A major improvement to the process and to finished water quality has been the addition of the mixing and metering header, and the automation of the finished water chemical dosing and controls.

### Automated and Remotely Monitored Treatment Process in Real Time

The WTP was operated manually from 1894 until the early 1990s, when a slow transition was made from manual to automatic operation. The improvements that were made included analog instrumentation and local control panels. Process monitoring over analog communications was transcribed by circular chart



Figure 6. Mixing and Metering Header.

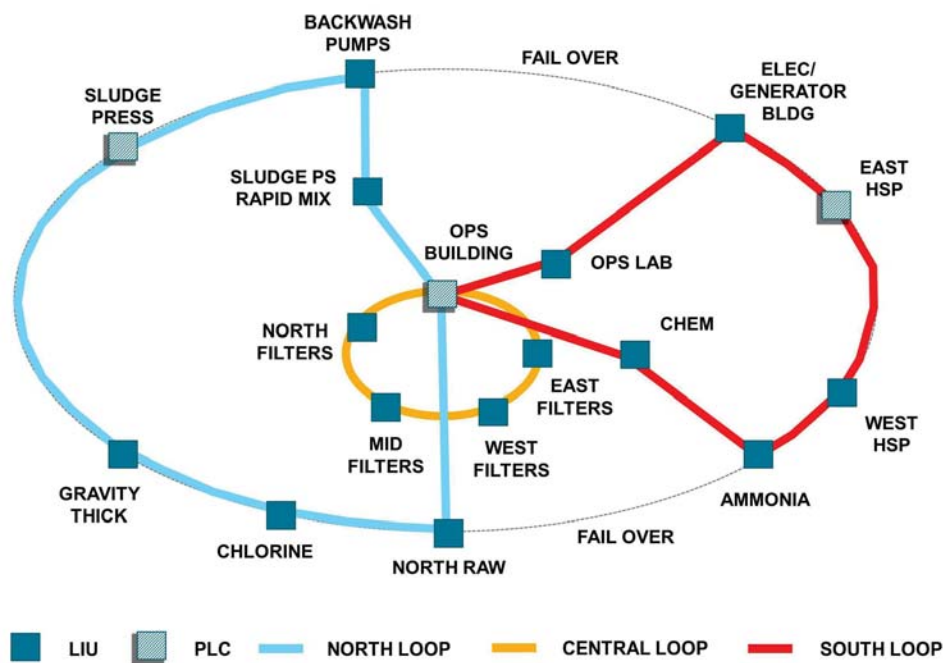

Figure 7. Triple-Ringed Fiber Optic Control Network Architecture.

recorders for operations and compliance reporting. In 1996, a complete plant upgrade was undertaken, including the addition of Siemens S5 programmable logic controllers (PLCs). New instruments and sensors were provided, while automatic control was achieved through actuation of valves throughout the WTP. Critical functions and controls were networked via fiber optic cable to the control room. In 2007, the filters were upgraded with new Siemens S7 PLCs and the communication network of the Rotork actuators was replaced to Profibus. In 2008, a radio telemetry network was installed to monitor and control the remote booster pump stations and PLC hard-

ware consisting of Allen Bradley CompactLogix and ControlLogix.

The development of the control system over this 20-year period spanned generations of SCADA technology evolution. Process monitoring and control systems of the WTP were stitched together as a patchwork quilt to meet the immediate needs of various projects without a unified framework. Operators interfaced process equipment through the Human Machine Interface (HMI) software, which differed greatly among the systems controlled. These inconsistencies in the software

*Continued on page 12*

Continued from page 11

and interface increased the potential risk of operator error.

To address these inconsistency issues, the control system was redesigned from the ground up. Efforts were made to standardize operation of devices via universally accepted communication protocols; these included Modbus, DeviceNet, Profibus and TCP/IP. Implementation of the new system was achieved with a phased approach: 1) fiber optic network construction, 2) PLC and remote rack installation, and 3) process software refinement. Following the construction of a triple-ringed fiber optic control network around the facility in 2009, the SCADA network was developed using twin 48-strand, 62.5 micron multimode fiber. Three PLCs operate separate control rings, which in turn operate a total of 22 local interface units (LIU) for a distributive control system, as illustrated in the network architecture graphic. These LIUs include fiber-to-ethernet converters to communicate to the remote PLC racks. The remote PLC racks communicate via hard wiring to the remote devices (i.e., pressure transmitters, flow switches, residual monitors, and turbidimeters). Five remotely located Thin Client touchscreens provide consistent and coherent graphic operator interfaces using Wonderware software for monitoring and control.

The City continues to make improvements to the control network. In 2013, MWH helped the City with equipment updates and adjustments to Profibus communications of the media filters.

The City faced serious challenges in the transitioning from existing to new SCADA, and could only allow for very limited facility shutdowns to facilitate system changeovers. The key was to avoid blind spots in the system and run parallel programming simultaneously in the old

and new systems to satisfy the health department's requirement of continuous monitoring. Each input/output (I/O) had to be moved one-by-one and verified before proceeding to the next. Naturally, the hardest part of the switchover comes when it's time to decommission and remove the fiber to the old remote terminal units (RTU). Therefore, old RTU obsolescence was verified by powering down the cabinets and confirming that no signals were lost and no unknown or undocumented junctions were overlooked.

As a result of the methodical improvements to the controls, the manual operation of flow control valves and chemical dosing pumps is now history, and the delayed process performance monitoring and control by periodic sampling and laboratory analysis is minimized. The process is now remotely monitored and controlled in real time with minimal manual intervention.

### High-Service Pump Rehabilitation

The seven existing high-service pumps range in age from 17 to 60 years. The pumps were evaluated to identify opportunities to increase capacity and reduce power consumption, either through operational improvements or equipment modifications. A condition assessment was conducted by MWH to document physical deficiencies of the existing pumps.

The condition assessment indicated the pumps were, generally, in good to fair condition, with a need for typical rehabilitation of pumps this age, including replacement of seals, wear rings, couplings, O-rings, nuts and bolts, coatings and exterior paint. Additionally, MWH compared the current performance of the pumps with the manufacturer pump curves to identify areas for improvement. This evaluation

identified the potential to increase the capacity of three high-service pumps with minor modifications to the existing impellers as follows:

- ◆ High-Service Pump 3 – The current impeller only draws 235 horsepower (hp) from the existing 300 hp motor. Additionally, the pump curve is “flat” and the operating head is much lower than the other pumps. This results in reduced output when the other pumps are in operation, making the pump least useful when it is most likely needed. Installing a larger-diameter impeller to take advantage of the existing 300 hp motor increases the operating head, thereby increasing the capacity of the pump.
- ◆ High-Service Pumps 6 and 7 – The pumps operate near the shutoff head and draw less than their rated capacity when the distribution system pressure is high. Installing larger-diameter impellers takes advantage of the existing motors to increase capacity with minimal capital cost.

Through detailed assessment and evaluation, the City was able to achieve cost savings by rehabilitating existing pumps, rather than purchasing new pumps, and increasing pump capacity by modifying, with minimal capital investment, the existing pumps to take advantage of existing motors and electrical supply.

### The Result: Finished Water Quality Improvements

In time, the improvement of the facility operations and finished water quality was broken down into four phases: operational improvements via staff augmentation and training (completed in mid-2008), filter improvements (completed in mid-2009), new mixing and metering header (completed in November 2011), and a new SCADA system (completed in February 2012).

Whereas previously, total chlorine, pH, color, and turbidity would fluctuate quite drastically, the finished water quality has become

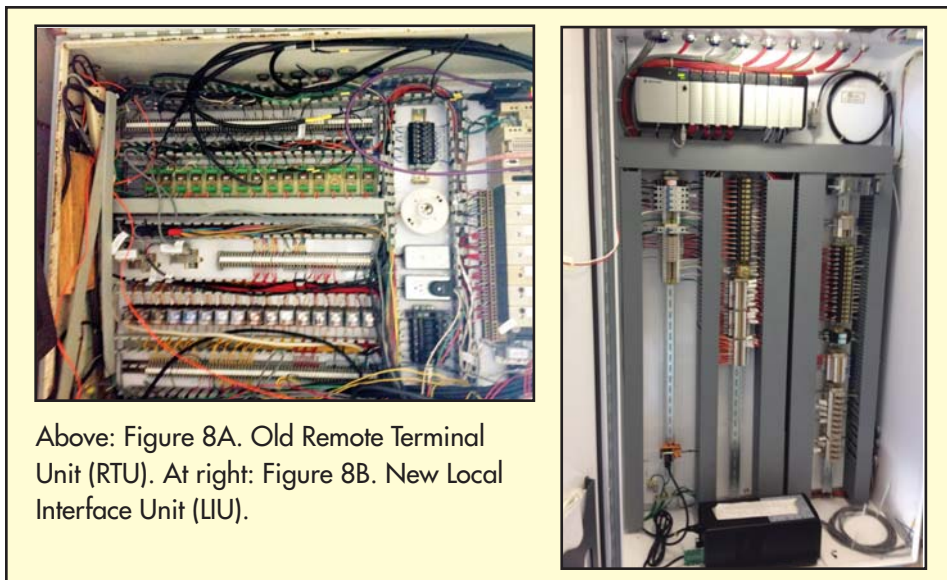

Figure 9. High-Service Pump No. 7.

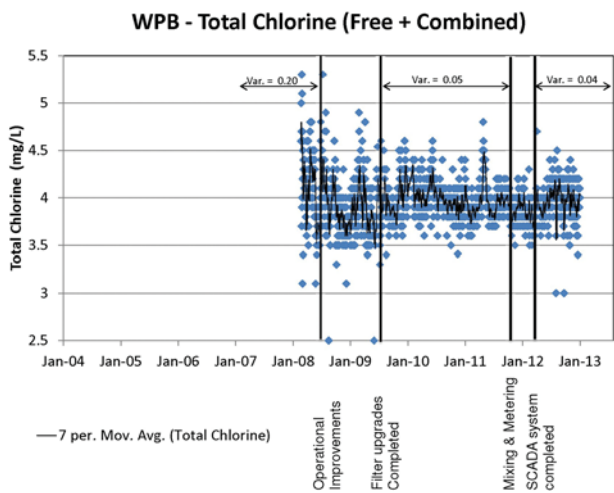

Figure 10A. Total Chlorine (Free + Combined)

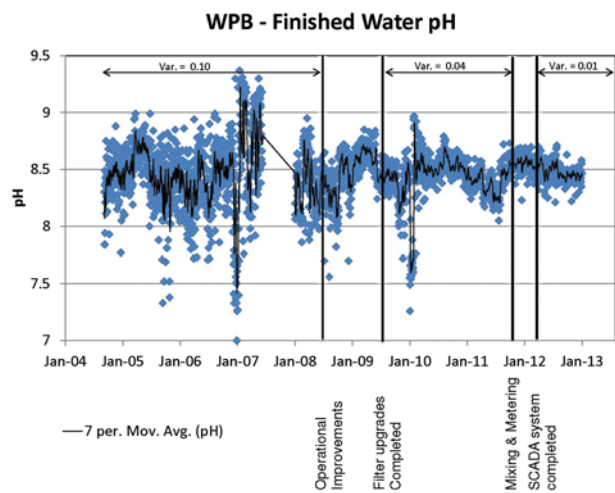

Figure 10B. Finished Water pH

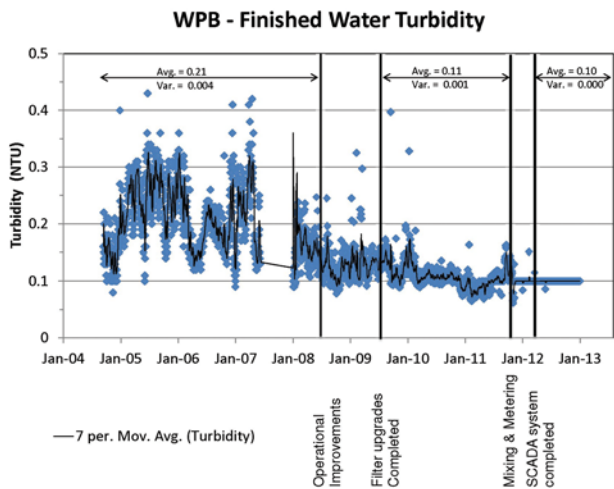

Figure 10C. Finished Water Turbidity

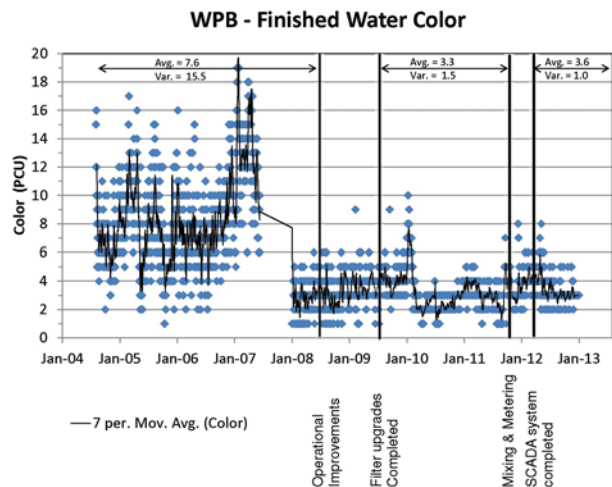

Figure 10D. Finished Water Color

Data sets were cleaned up for outliers, anomalies, and readings below detectable limit (BDL). Turbidity data recorded as < 0.1 is depicted as 0.1. Color data recorded as < 3 is depicted as 3.0.

more stable, evident in the trends and variances of the daily data obtained from monthly operating reports and the SCADA system. The graphs for total chlorine and pH, particularly, show the narrower band in which total chlorine and pH are controlled in the finished water. For instance, the variance of the finished water pH dropped from 0.10 to 0.04 when operations were augmented by contract staff trained in mid-2008, with a further reduction to 0.01 when the mixing and metering header and SCADA system were completed in early 2012. The graph for finished water turbidity shows a consistent downward trend since the first improvements were made in mid-2008. Operations augmentation and training helped reduce average turbidity levels from 0.21 to 0.11 nephelometric turbidity unit (NTU), but another step-change improvement to a turbidity of 0.10 NTU was made with the completion of the SCADA system in early 2012. The graph for fin-

ished water color, on the other hand, shows the step-change improvement in mid-2008 when the operations instigated the more frequent sampling regime (every 4 hours) on the settled water to ensure the ferric sulfate and lime dosing and pH conditions were always kept optimum for maximum organics and color removal in the sedimentation basins. The average color levels dropped from 7.6 to 3.3 PCU when this operational change was made.

### Summary

Through new controls hardware and software, the West Palm Beach WTP is more reliable and produces more consistent finished water quality with minimal manual intervention. Hazardous, gaseous chlorine and ammonia have been replaced with liquids, and a new safe access driveway provides safer ingress and egress. Obsolete chemical systems have been au-

tomated and replaced with state-of-the-art equipment. A new electrical/generator building with an express power feed is under construction with double-ended switchgear and standby generators providing reliably power to all equipment, with an option to seamlessly transfer between utility and generator power.

With the right infrastructure and improved operator attention, significant improvements have been made to the water treatment process evidenced by improved finished water quality and operational reliability.

### Acknowledgements

Thanks from MWH go to the City of West Palm Beach for its support and to acknowledge the following team members who contributed to the improvements at the WTP: Jacobs Engineering and subconsultants GlobalTech, Song+Associates, and Integration Systems Incorporated. ☺